



Control of Wastewater Treatment by using the Integration MATLAB and LabVIEW

Ilanur Muhaini Mohd Noor and Muhamad Kamal M. A.

Bio-Inspired System and Technology Research Group, Malaysia-Japan International Institute of Technology (MJIT), Universiti Teknologi Malaysia (UTM), Kuala Lumpur, Malaysia

ABSTRACT

This research attempts to enhance of the ability of Fuzzy Logic Controller in controlling wastewater treatment system, highlighting the pH parameter in factory wastewater treatment plants. The research not only covers methods to monitor and track the pH level in wastewater tank but more importantly, the control of total wastewater volume by neutralising the pH. Fuzzy logic control has gained more attention in the control of continuous processes. It utilised both, in the context of deciding and tracking set-points, and to control the total unwanted water capacity. This paper also discusses suitable level of pH required which will not damage the water ecosystem. The self-learning fuzzy logic control with adaptive capabilities alert operator in charge of the pH level automatically. This research includes the design and development a graphical user interface (GUI) to show the process of pH neutralisation in wastewater treatment. A fast response system is achieved through GUI which could be monitored and control remotely using laptop or smartphone, from anywhere. This proposed design will inform engineers and technicians about the status of the current reading of parameters in the wastewater treatment system without the hassle of going to the site or control room of the wastewater treatment plant.

Keywords: Fuzzy Logic Controller, pH, MATLAB, LabVIEW

INTRODUCTION

This research has been carried out to analyse fuzzy logic used in controlling process tank

in industrial wastewater systems. The process of wastewater treatment is complicated and nonlinear. This research introduces an effective and robust control approach to control concentration in a wastewater treatment process. In this research, focus will be on pH, which is one of the parameters involved in wastewater treatment. In wastewater treatment, the pH is controlled to maintain the pH to neutral value which is within the range of 6 to 8 according to

ARTICLE INFO

Article history:

Received: 24 August 2016

Accepted: 02 December 2016

E-mail addresses:

ilanur@hotmail.com (Ilanur Muhaini Mohd Noor)

mkamalma@upm.my (Muhamad Kamal M.A)

*Corresponding Author

statistics from United Nations (UNDESA, 2006). Neutralisation is a process of adding acid or alkali solution to waste water in order to obtain the neutral pH range (pH 7). pH (hydronium potential) neutralisation process control plays an important role in the control of pH level in numerous industries such as biotechnology, manufacturing, chemical, sewage treatment, paper factory, pharmaceutical, agriculture, food processing, research laboratories, rain water harvesting, waste water treatment and many other industries where a certain pH level has to be maintained for suitable applications. pH levels of waste water produced by factories have to be controlled and maintained at neutral range before the effluent is discharged in accordance to environmental regulations. The focus of this research is to design and implement a fuzzy controller to obtain a neutral pH for the wastewater treatment plant using LabVIEW software and to simulate the pH level of mix tank with randomly sensed pH values before analysing the non-linear system.

The main idea of the research is to control the flow rate of acid liquid and alkali liquid into the mix tank to maintain the mix tank at neutral pH which is 7. The manner in which the flow rate is quantified depends on whether the quantity flowing is a solid, liquid or gas. For solid, it is appropriate to measure the rate of mass flow, whereas in the case of liquid and gases, flow is usually measured in terms of the volume flow rate. The system will calculate the concentration (M) based on the pH value after the wastewater pH value in the mix tank is sensed. If the pH value is 7, then no acid or base will be pumped into the mix tank but if it is less or more than 7, then it will recalculate the concentration value so that a specific amount of acid or base will be added. Results of the output level of the mix tank after randomly accomplishing inputs from pH sensor in the mix tank. By implementing fuzzy algorithms based on the pH level sensed by the sensor the valve opening of respected acid or alkali solution can be generated in order to achieve the neutral range. Wright and Kravaris (1991) said that “by measuring the effluent pH it is impossible to uniquely determine the effluent ion concentrations and by manipulating the titration stream flow rate it is impossible to move the effluent concentrations to arbitrary values”. Hence, as the influent stream changes, the titration curve also changes significantly, so an efficient system is necessary in producing satisfactory results. A strategic method to solve nonlinearity and time delay in pH control was introduced by Wang et al. (2009) where predictive control model was used based on hierarchical optimisation in rolling mill waste water treatment (Takekawa et al., 2010). Fuzzy control was applied to a “P” and “PD” plant to perform pH control by De Azevedo et al. (2011) for neutralising rain water in order to reuse it; a comparison was also done between the controllers. An analysis of the system was done under two different circumstances, namely where only error was considered for the plant input and variation of error was considered in the other situation. Fuzzy logic based PID control of pH neutralisation process was carried out by researchers Jebarani, D, I. & Rammohan, T. (2014) for waste water treatment systems. The input to the fuzzy control was based on the feedback from the output values of the PID controller and with reference to set point whereby a new value is set for the PID flow rate controller.

METHODOLOGY

The pH value and Molar Concept

The pH value of a substance is directly related to the ratio of the hydrogen ion $[H^+]$ and the hydroxyl ion $[OH^-]$ concentrations. If the H^+ concentration is greater than OH^- , the material is acidic, i.e., the pH value is less than 7. If the OH^- concentration is greater than H^+ , the material is basic, with a pH value greater than 7. If equal amounts of H^+ and OH^- ions are present, the material is neutral, with a pH of 7. Acids and bases have free hydrogen and hydroxyl ions respectively. Since pH is a logarithmic function, a change of one pH unit represents a ten-fold change in hydrogen ion concentration. There are miscellaneous bacteria involved in anaerobic sludge digestion (Feng et al., 2009) and the growth rate is affected by pH. A mole of a compound is defined as Avogadro's number of molecules (6.02×10^{23} molecules), which has a mass approximately equal to the molecular weight, expressed in grams. For example, sodium hydroxide, NaOH, which has a molecular weight of $23+16+1=40$, would have 40 grams in a mole. Since the atomic weight of the hydrogen ion (H^+) is one (1), there is one gram of hydrogen ions in a mole of hydrogen. A solution with a pH of 10 has 1×10^{-10} moles of hydrogen ions, or 10^{-10} grams in a one litre solution (Cosmin et al., 2012).

Fuzzy Logic Controller

In this research, the aim is to maintain the pH level of wastewater mix tank to pH 7 which is the neutral pH. Based on the value of pH sensed by the pH sensor in the mix tank, either one of the tank which consists of acid or alkali will be pumped into the mix tank. If the pH sensor in the mix tank shows pH less than 7, it is considered as acidic. Therefore, a certain amount of alkali will be pumped into the mix tank to maintain the pH to neutral value. If the pH sensor in the mix tank shows pH more than 7 (between 8-14) then it is considered as base. Therefore, certain amount of acid will be pumped into the mix tank to maintain the pH to neutral value. If the pH sensed by sensor in the mix tank shows the pH to be exactly 7, then both valve for alkali and acid will be closed to make sure that none of it is pump into the mix tank. Advantages of using a fuzzy logic system is that it has the capability of controlling nonlinearity by formalising the set of rules set by human to act intelligently in providing the output.

Construction of System Using Fuzzy Logic Toolbox

The Fuzzy Logic Toolbox could create and edit fuzzy inference systems. These systems could be created using graphical tools or command-line functions, or it could be generated automatically using either clustering or adaptive neuro-fuzzy techniques (Sabri & Almshat, 2015). In the Fuzzy Inference System or FIS Editor, the first step is to design the fuzzy controller. In this editor, the input and output variable are included. The Mamdani (2004) method is used for the system.

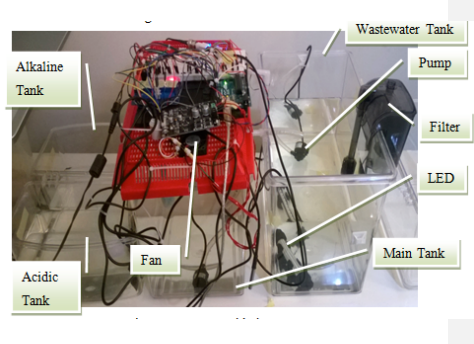
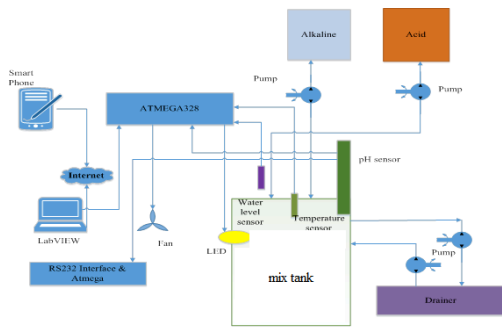

Figure 2.0. Hardware components interfaced with LabVIEW Figure 2.1. Low cost prototype

A low-cost microcontroller was used (Arduino Uno) to control the whole system (Figure 2.0). A research was carried out with low cost prototype (Figure 2.1) which can be interfaced with the GUI created and provided faster response in the neutralisation process. The main control element in the neutralisation system is the control valve. Even though low cost components and materials were used, it did not compromise the outcome. It has to be noted that there must not be any delay in the polling of data and controlling of the system between the GUI and the prototype. Testing was done after interfacing the hardware with the GUI using serial cable. Control signals were sent from the GUI and the response was observed from the prototype. The wiring diagram is the control circuitry illustration (Figure 2.2) sketched using Proteus software. As shown in Figure 2.2, controller was connected to three different inputs and outputs mechanism.

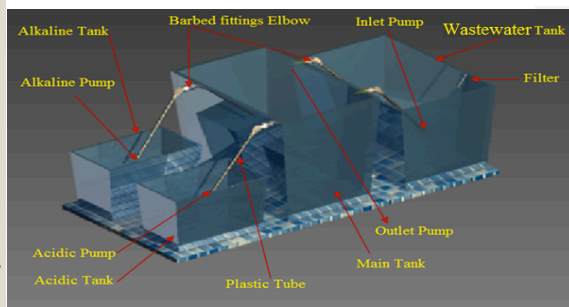
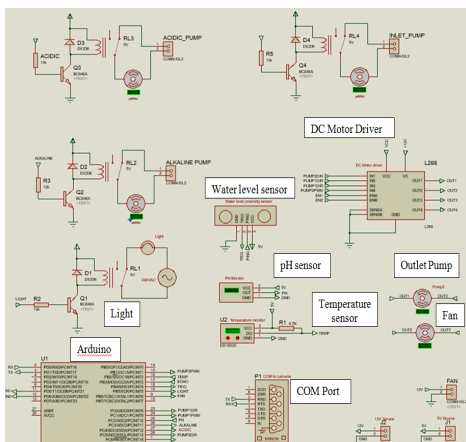

Figure 2.2. Wiring diagram

Figure 2.3. 3D

Design of the prototype

The position, size and the number of the tanks were selected due to their availability and reduced power consumption as shown in Figure 2.3. If tanks are not placed at the same level, there will be increased power consumption because pumps are operating against gravity with higher elevation difference.

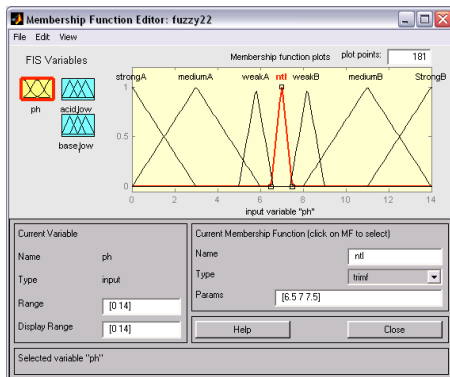

Figure 3.1. Membership Function Editor of pH

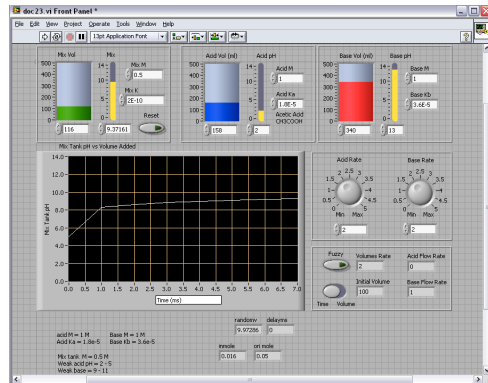

Figure 3.2. Front panel of the completed project

RESULTS AND DISCUSSION

To measure the current pH (to remain at or near neutral level or within some range), and have control over two valves for the acid tank and alkali (base) tank to be pumped into the mix tank, the following steps need to be followed as shown in Membership Function Editor of Figure 3.1:

- i) Establish fuzzy membership functions for pH, such as “Strong acid”, “Medium acid”, “Weak acid”, “Neutral”, “Weak Base”, “Medium Base” and “Strong Base”. This will need to be done for pH rate of change or any other derivatives of pH as well.
- ii) Establish fuzzy membership functions (Figure 3.1) for the two outputs flow rate, one for acid tank and the other for base tank, such as “Off”, “Slow”, “Medium” and “Fast”.
- iii) Write rules linking the desired outputs to the given inputs, for example: (if pH is strong acid (strong A) then acid flow is off and base_flow is fast)

The front panel (Figure 3.2) is where the Graphical User Interface (GUI) is located. Users could set in any first value of the pH, and it will generate automatically random pH value to be simulated. In the real situation, this first value is being sensed by the pH sensor in the plant and the signal is sent to the software via data acquisition (DAQ card). At the same time, volume of wastage in the mix tank will be reduced and which can be viewed in this panel. There are two indicators: pH level indicator and volume indicator in the mix tank. Another two sets of similar tank volume and pH indicator is shown for acid and alkali tanks. The simulation could be viewed in two different forms. One by inserting the fuzzy system in the system and the other one without it. The graph could also be viewed in two different units. One is pH versus time

and the other is pH versus volume inserted. Acid and base flow rate could be adjusted by using two knobs, which resemble valves, at the right side of the front panel. In the programming section (block diagram) in Figure 3.3, it consists of few subs VI, function icon, and a loop including the pH of Acid, pH of Base, Number of Mol, For Loop, Subtract Icon, Add Icon, Less Icon, MATLAB script editor to call MATLAB fuzzy logic controller file into LabVIEW environment and MATLAB m-files programming modules on various tasks.

When the pH is 1.862 (Figure 3.4) which is acidic, there will be no acid flow into the mix tank but there will be 0.56ml/ms of base flows into the mix tank. Therefore, in the rule viewer of Figure 3.4, acid flow = 0 and base flow = 0.56ml/ms. When the pH is 12.78 (Figure 3.5) which is alkaline, there will be no base flow into the mix tank but there will be 0.601ml/ms of acid flows into the mix tank. Therefore, in the rule viewer of Figure 3.5, acid flow = 0.601ml/ms and base flow = 0.

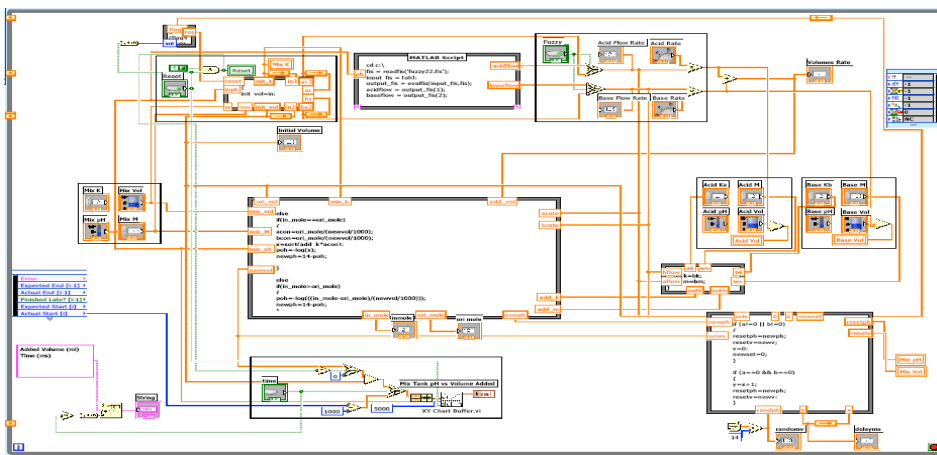

Figure 3.3. Block diagram (programming) of the whole research

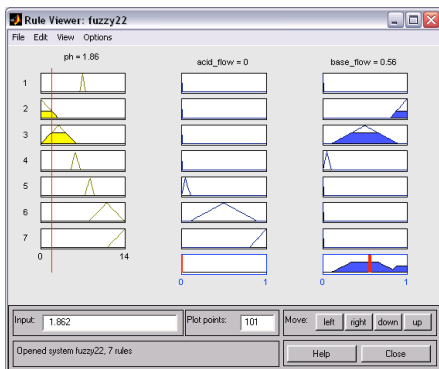

Figure 3.4. Rule viewer at pH 1.862

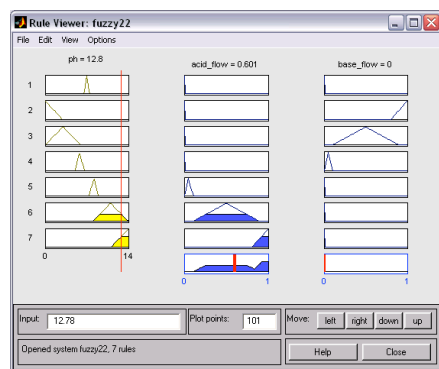

Figure 3.5. Rule viewer at pH 12.78

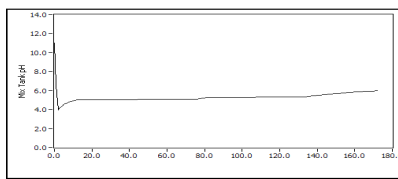

Figure 3.7. pH sensed in Mix tank versus time

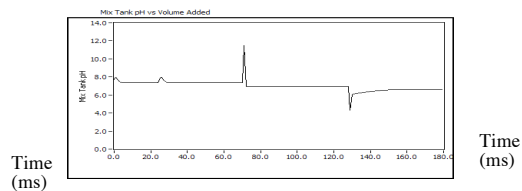

Figure 3.8. pH in Mix tank versus time

Results of the output level of the mix tank after randomly accomplishing inputs from pH sensor in the mix tank

In Figure 3.6, as soon as the pH level in the mix tank is 11, the system will drop the pH level in mix tank to pH 4 for the first 2.0 ms. After 2.0 ms, it will slowly increase to neutral starting from pH 4 to pH 7. This figure shows the time from 0 ms to 180.0 ms. For Figure 3.7, as soon as the pH level in the mix tank is 8, the system will drop the pH level in mix tank to pH 7 for the first 70.0 ms. After 70.0 ms it drastically increases to pH 11. This happens due to chemical reaction but it drastically drops to neutral at 73.0ms. This figure shows the time from 0ms to 180.0 ms. This chemical reaction again happens at 130.0 ms but increases to the neutral value again after that. This shows that even though it is hard to predict when the chemical reaction drastically changes the graph but a well-designed system could bring the pH value back to the desired neutral value. Therefore, the characteristics of Figure 3.6 and Figure 3.7, show that even though the time exceeds to 180ms, the system maintains the mix tank pH at values which approaches neutral. The objective of this research was to maintain pH level at neutral in the mix tank which was achieved here. Huan et al. (2014) proposed network via wireless system to android phone. This system will enable engineers and technicians to be alert about the status of the current reading of parameters in the wastewater treatment system without hassle to go to the site or control room of the wastewater treatment plant.

CONCLUSION

The system that had been created could maintain the pH level at neutral whenever random values are supplied to the mix tank. This mix tank is especially important in the industrial area because industries usually throw their prerequisite liquid which could affect the environment. This research has shown that pH control is a non-linear and it could be controlled using fuzzy logic controller. The system could be remotely controlled from anywhere by using online system connected to the proposed project. The rating of the overall system performance can be up to 95%.

REFERENCES

Cosmin, D., Ramona, H., Ruben, c. & Ioan, n. (2012). Modelling and Internal Model Control Strategy of pH Neutralization Process. *Institute of Electrical and Electronics Engineers*, 12, 1579-1582.

- de Azevedo Dantas, A. F. O., de Lima, F. A., Maitelli, A. L., & Dantas, G. F. (2011, November). Comparative study of strategies for fuzzy control P and PD applied to a pH plant. In *IECON 2011-37th Annual Conference on IEEE Industrial Electronics Society* (pp. 516-521). IEEE.
- Huan, J., Liu, X., Li, H. Wang, H. & Zhu, x. (2014) A monitoring and control system for aquaculture via wireless network and android platform. *Journal of Sensors and Transducers*, 169, 250-256.
- Jebarani, D, I. & Rammohan, T. (2014). Fuzzy Logic based PID Controller for pH Neutralization Process. *International Journal of Computer Applications*, 95(6), 36-39.
- L.Y. Feng, Y.Y. Yan, Y.G. Chen (2009). Kinetic analysis of waste activated sludge hydrolysis and short-chain fatty acids production at pH 10. *Journal of Environment Science*, 21(5), 589–594.
- Mamdani, E.H. (2004). Soft computing as a tool, Fuzzy Systems. In *Proceedings of IEEE International Conference on*, (Vo.1, pp. 31 – 31). IEEE.
- Sabri, I., & Almshat, H. (2015). Implementation of fuzzy and PID controller to water level system using LabVIEW. *International Journal of Computer Applications*, 116(11), 6-10.
- Takekawa, M., Aoki, J., Nakaya, M., Ohtani, T. & Ohtsuka, T. (2010). An Application of Nonlinear Model Predictive Control using C/GMRES method to a pH Neutralization Process. In *SICE Annual Conference, Taipei*, 18th -21st August 2010. (pp. 1494-1496).
- Wang, W., Long, W., & Hu, L. (2009, May). Nonlinear Model Predictive Control of pH in Rolling Mill Wastewater Treatment. In *Intelligent Systems and Applications, 2009. ISA 2009. International Workshop on* (pp. 1-5). IEEE.
- Wright, R. A., & Kravaris, C. (1991). Nonlinear control of pH processes using the strong acid equivalent. *Industrial and Engineering Chemistry Research*, 30(7), 1561-1572.