

Unbalanced Self-Sensing Actuation Circuit Effects on Vibration Control in Piezoelectric Systems

Kiattisak Sengchuai^{1*}, Boworn Panyavoravaj² and Nattha Jindapetch¹

¹Department of Electrical Engineering, Faculty of Engineering, Prince of Songkla University, Hat Yai, Songkhla 90112, Thailand

²Western Digital (Thailand) CO., LTD. Bang Pa-in, Phra Nakhon Si Ayutthaya 13160, Thailand

ABSTRACT

Self-sensing actuation (SSA) is a technique to use a single piezoelectric actuator as both an actuator and a sensor simultaneously. A self-sensing actuation circuit is used to extract a voltage generated by a piezoelectric actuator from a control voltage. However, the SSA circuit must be balanced to obtain an accurate sensing voltage. This paper describes an effect of an unbalanced SSA circuit on the sensing voltage output. The SSA circuit is connected to a piezoelectric system to apply the control voltage and measure the generated voltage simultaneously. The unbalanced SSA circuit is configured by designing an equivalent capacitance parameter to be not equal to a piezoelectric capacitance. The unbalanced SSA circuit effects is evaluated in terms of the step response and the frequency response. An experiment is conducted in an open-loop system and a closed-loop system. In the open-loop system, the sensing voltage is observed when the control voltage is applied to the piezoelectric actuator. In the closed-loop control system, a positive position feedback (PPF) controller is used for vibration control at a resonant frequency of the piezoelectric system. Experimental results show that the unbalanced SSA circuit causes the sensing voltage error when the amplitude of the control voltage is larger than the amplitude of the voltage generated from the piezoelectric actuator. In this case study, the unbalanced SSA circuit does not affect the vibration control at the resonant frequency in the closed-loop system. The vibration of the piezoelectric system at the resonant frequency is attenuated by 16 dB in both the balanced and the unbalanced SSA circuit conditions.

Keywords: Self-sensing actuation circuit, unbalanced SSA circuit, piezoelectric actuator, vibration control

ARTICLE INFO

Article history:

Received: 24 August 2016

Accepted: 02 December 2016

E-mail addresses:

ak.kiattisak@hotmail.com (Kiattisak Sengchuai),

boworn.panyavoravaj@wdcc.com (Boworn Panyavoravaj),

nattha.s@psu.ac.th (Nattha Jindapetch)

*Corresponding Author

INTRODUCTION

Piezoelectric materials are widely employed in electromechanical systems to act as an actuator or a sensor. Advantages of

piezoelectric materials are light weight, high resolution, high bandwidth, fast response, and simple input/output. These piezoelectric materials can be used in many applications, such as vibration control, precision control, health monitoring, and so on. In piezoelectric actuator applications, the mechanical strain (or stress) is produced by applying the electric field (or voltage) to a piezoelectric actuator. In piezoelectric sensor applications, the electrical charge (or voltage) is produced by the mechanical strain (or stress) in a piezoelectric sensor.

Self-sensing actuation (SSA) is a technique to use a single piezoelectric actuator as both an actuator and a sensor simultaneously. The concept of the self-sensing actuation was initially proposed by Dosch, Inman, and Garcla (1992) which was based on a bridge circuit. The advantages of a self-sensing actuation is its lower cost for adding external sensors as well as the piezoelectric materials. In addition, the self-sensing actuation is utilised in different applications, such as a vibration control (Seki & Iwasaki, 2014), a position and force control (Rakotondrabe, Ivan, Khadraoui, Lutz, & Chaillet, 2015), and a mass detection (Faegh, Jalili, & Sridhar, 2013).

Self-sensing actuation circuit is used to separate the voltage generated by a piezoelectric actuator from the control voltage. This control voltage is applied to the same piezoelectric actuator. The SSA circuit was first proposed in Dosch et al. (1992) which was the bridge circuit. The bridge circuit SSA is used for a vibration suppression of a structure, such as a cantilever beam (Ji, Qiu, Wu, Cheng, & Ichchou, 2011), and an R/W head suspension in a hard disk drive (Yamada, Sasaki, & Nam, 2008). This SSA circuit is easy to understand and implement, but it attenuates the control voltage applied to a piezoelectric actuator by a parameter of the circuit. To solve the control voltage attenuation, an indirect-driven SSA (IDSSA) circuit was proposed in Hong, Memon, Wong, and Pang (2010) and Hong and Pang (2012). The IDSSA circuit was implemented in a piezoelectric micro-actuator in a dual-stage hard disk drive for a vibration control at critical resonant modes. However, it is difficult to make this IDSSA circuit balance.

In this paper, we study the effects of an unbalanced SSA circuit on the sensing voltage output of the SSA circuit. The effects of the unbalanced SSA circuit were evaluated in terms of the step response and the frequency response in both the open-loop control system and the closed-loop control system. This paper describes the self-sensing actuation circuit, the experimental setup, the experimental results, and the conclusion.

SELF-SENSING ACTUATION CIRCUIT

The self-sensing actuation (SSA) circuit is used to extract the voltage generated by the piezoelectric actuator from the control voltage. The structure of the self-sensing actuation circuit was proposed in Hong et al. (2010) as shown in Figure 1. The piezoelectric actuator can be modelled as a series of a voltage source V_p and a piezoelectric capacitance C_p . The control voltage V_c is applied to the piezoelectric actuator via the non-inverting (+) input terminal of the upper operation amplifier. The voltage V_p generated from the piezoelectric actuator can be extracted by balancing the SSA circuit.

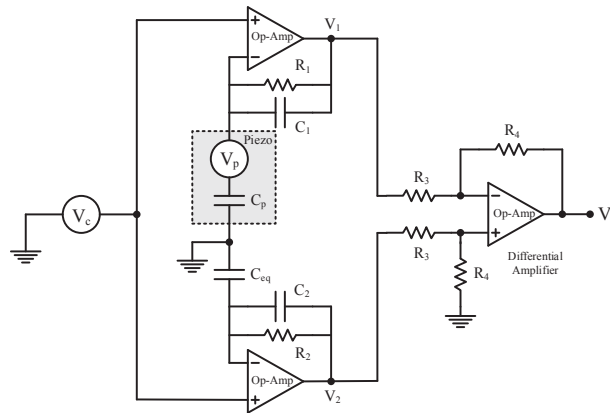

Figure 1. A self-sensing actuation circuit (Hong et al., 2010).

SSA circuit model

The circuit in Figure 1 is composed of the piezoelectric actuator, four resistors (R_1, R_2, R_3, R_4), three capacitors (C_{eq}, C_1, C_2), and three operation amplifiers (Op-Amp). This circuit can be analysed by deriving the Laplace transform of V_1 and V_2 as expressed by (1) and (2) respectively.

$$V_1(s) = \left(1 + \frac{R_1 C_p s}{R_1 C_1 s + 1}\right) V_c(s) - \frac{R_1 C_p s}{R_1 C_1 s + 1} V_p(s) \quad (1)$$

$$V_2(s) = \left(1 + \frac{R_2 C_{eq} s}{R_2 C_2 s + 1}\right) V_c(s) \quad (2)$$

If $R_3 = R_4$, the sensing voltage V can be calculated as (3). Note that R_3 and R_4 only affect to the gain of the differential amplifier.

$$V_s(s) = \frac{R_4}{R_3} (V_2(s) - V_1(s)) = \left(\frac{R_2 C_{eq} s}{R_2 C_2 s + 1} - \frac{R_1 C_p s}{R_1 C_1 s + 1}\right) V_c(s) + \frac{R_1 C_p s}{R_1 C_1 s + 1} V_p(s) \quad (3)$$

If $\omega_c \gg 1/R_1 C_1$ and $\omega_c \gg 1/R_2 C_2$, the sensing voltage V_s can be rewritten as (4), where ω_c is the frequency of control voltage V_c .

$$V_s(s) = \left(\frac{C_{eq}}{C_2} - \frac{C_p}{C_1}\right) V_c(s) + \frac{C_p}{C_1} V_p(s) \quad (4)$$

The sensing voltage V_s is composed of the control voltage V_c term and the generated voltage V_p term. The voltage V_p generated from the piezoelectric actuator can be decoupled from the control voltage V_c by balancing the SSA circuit.

Balanced SSA circuit

The SSA circuit is balanced by designing the parameters $C_{eq} = C_p$ and $C_1 = C_2$. The sensing voltage V_s is proportional to the generated voltage V_p as defined in (5).

$$V_s(s) = \frac{C_p}{C_1} V_p(s) \quad (5)$$

Unbalanced SSA circuit

The parameter C_{eq} in the SSA circuit cannot be designed to match the piezoelectric capacitance C_p because the actual piezoelectric capacitance is unknown. Therefore, the parameter C_{eq} can be defined as (6).

$$C_{eq} = C_{eq0} + \Delta C_{eq} \quad (6)$$

Assume that $C_{eq0} = C_p$ and $C_1 = C_2$, the sensing voltage V_s can be rewritten as (7). Note that C_1 and C_2 can affect the unbalanced circuit. However, they can be easily designed to have the same value.

$$V_s(s) = \frac{\Delta C_{eq}}{C_2} V_c(s) + \frac{C_p}{C_1} V_p(s) \quad (7)$$

The sensing voltage V_s in (7) is composed of the control voltage V_c term and the generated voltage V_p term. The former term is close to zero when the SSA circuit is balanced. In contrast, V_s contains both terms when the SSA circuit is unbalanced. In this paper, the effect of the unbalanced circuit on the sensing voltage is studied through the real experiment because the transfer function model of the piezoelectric actuator is unknown.

EXPERIMENTAL SETUP

The block diagram of the experiment is shown in Figure 2. The SSA circuit is implemented according to the SSA circuit in Figure 1. It is connected to the piezoelectric system to apply the control voltage to the piezoelectric actuator and measure the voltage generated from the piezoelectric actuator. The piezoelectric system is composed of two piezoelectric actuators. One piezoelectric actuator is used as the self-sensing actuator, and the other is used as a disturbance source of the system. The sensing voltage measured from the SSA circuit is fed to the MATLAB

Simulink in the computer via A/D of the NI PCI-6024E board. The control voltage generated by the MATLAB Simulink is applied to the piezoelectric actuator via D/A of the NI board. The sampling frequency of A/D and D/A is 50 kHz. The experimental setup is shown in Figure 3.

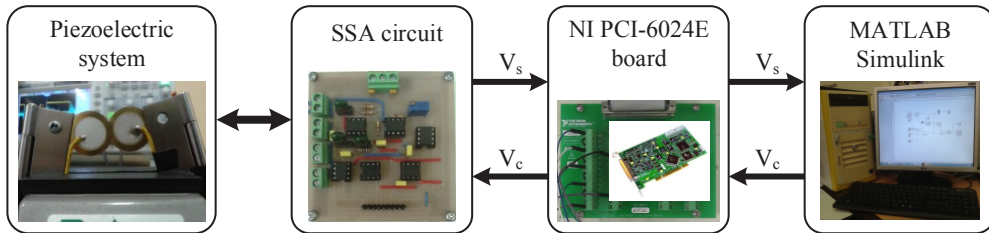

Figure 2. The experiment block diagram

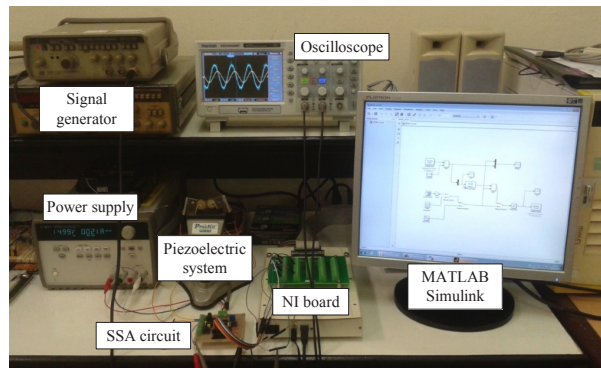

Figure 3. The experimental setup

The SSA circuit is implemented in a print circuit board (PCB). The operation amplifiers in the circuit are implemented by the LF351 op-amp chips which have high bandwidth and high input impedance. The values of parameters in the SSA circuit are listed in Table 1.

Table 1
Circuit parameters

Circuit parameters	Value
C_p	26 nF
$C_1 = C_2$	22 nF
$R_1 = R_2$	10 M Ω
$R_3 = R_4$	10 k Ω

In the experiment, the step response and the frequency response is studied in both the open-loop control system and the closed-loop control system. In the step response test, the control voltage V_c is applied by the step signal with 1 V amplitude. In the frequency response test, the control voltage V_c is applied by the swept sine signal in the frequency range of 100 Hz to 10 kHz with 1 V amplitude. The frequency response V_s/V_c of the SSA circuit with the piezoelectric system is obtained by applying the control voltage V_c and measuring the sensing voltage V_s .

EXPERIMENTAL RESULTS

The experiments are conducted in the open-loop system and the closed-loop system to study the effects of unbalanced SSA circuit on the sensing voltage output. The balanced SSA circuit is configured by designing the parameter $C_{eq} \approx C_p$. The unbalanced SSA circuit can be configured by designing the parameter $C_{eq} \neq C_p$. In this paper, the parameter C_{eq} is designed to 23 nF ($C_{eq} < C_p$) and 29 nF ($C_{eq} > C_p$).

Open-loop system

The step responses of the open-loop system are shown in Figure 4. These responses demonstrate the effect of the balanced and unbalanced SSA circuit conditions on the sensing voltage V_s . The sensing voltage of the balanced SSA circuit demonstrates that the generated voltage V_p relates to the vibration of the piezoelectric system at the resonant frequency. In the unbalanced SSA circuit, the sensing voltage is composed of the control voltage and the generated voltage V_p . Obviously, this behaviour conforms to (7). The unbalanced SSA circuit causes the sensing voltage error because the amplitude of the generated voltage is smaller than the amplitude of the control voltage.

The frequency responses of the open-loop system with the balanced and unbalanced SSA circuit conditions are shown in Figure 5. The frequency response result shows the resonant frequency of the piezoelectric system at 2.9 kHz. The frequency response of the balanced and the unbalanced SSA circuit conditions are the same at the resonant frequency because

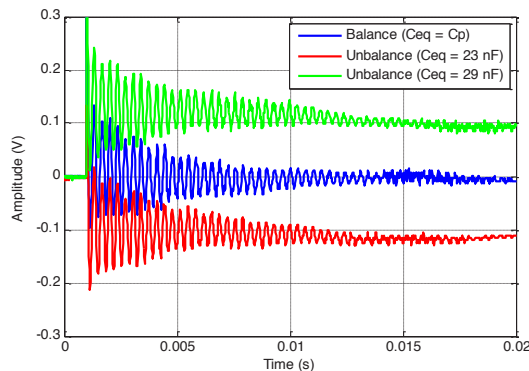

Figure 4. The step responses of the open-loop system

Unbalanced Self-Sensing Actuation Circuit Effects

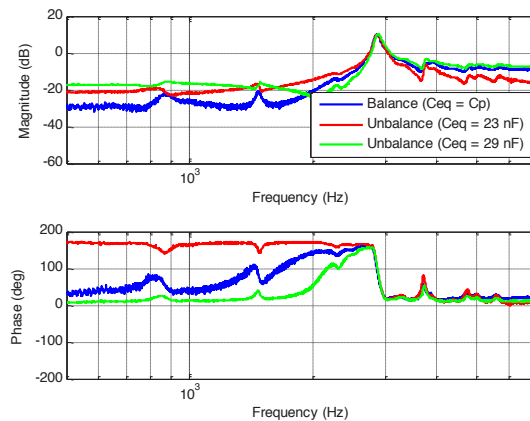

Figure 5. The frequency responses of the open-loop system

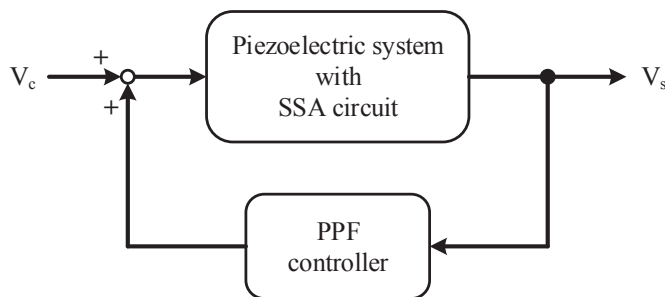

Figure 6. The closed-loop control system block diagram.

the amplitude of the generated voltage is larger than the amplitude of the control voltage. However, the unbalanced SSA circuit effects can be observed at the other frequencies because the piezoelectric system slightly responds and the amplitude of the generated voltage is smaller than the amplitude of the control voltage.

Closed-loop system

The block diagram of the closed-loop control system for the vibration control at the resonant frequency is shown in Figure 6. The positive position feedback (PPF) controller is used to control the vibration of the piezoelectric system. The sensing voltage V_s measured from the SSA circuit is fed back to the PPF controller. In this paper, the transfer function of the PPF controller defined in Sasaki, Inoue, and Yamada (2012) is used as shown in (8).

$$G_c(s) = K \frac{\omega^2}{s^2 + 2\zeta\omega s + \omega^2} \quad (8)$$

where ω is the natural frequency of the controller, ζ is the damping ratio of the controller, and K is the gain of the controller. In this experiment, the natural frequency is 2.9 kHz ($\omega = 2900$), the damping ratio is 0.2 ($\zeta = 0.2$), and the gain is -0.7 ($K = -0.7$). The PPF controller is implemented on the MATLAB Simulink.

The step responses of the open-loop system and the closed-loop system with the balanced and unbalanced SSA circuit conditions are shown in Figure 7. These responses show the effectiveness of the vibration control by using the sensing voltage V_s measured from the SSA circuit and fed back to the PPF controller. The vibration of the piezoelectric system can be suppressed in the closed-loop control system. However, the sensing voltage output of the SSA circuit is effected from the unbalanced SSA circuit because the amplitude of the control voltage applied by the step signal is larger than the amplitude of the voltage generated by the piezoelectric actuator as shown in Figure 7(b) and (c).

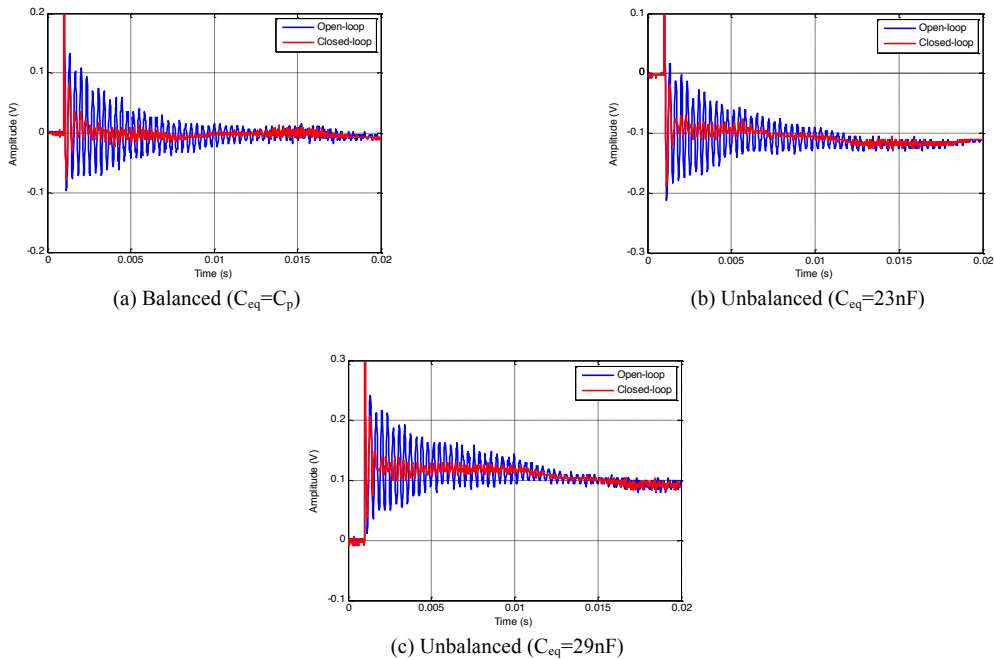

Figure 7. The step responses of the closed-loop system

The frequency responses of the closed-loop control system with the balanced and unbalanced SSA circuit conditions are shown in Figure 8. The vibration of the piezoelectric system is attenuated about 16 dB in both the balanced and the unbalanced SSA circuit conditions at the resonant frequency. In this case study, the unbalanced SSA circuit does not affect to the closed-loop control system because the former (unbalanced SSA circuit) slightly affects the sensing voltage fed back to the controller.

Unbalanced Self-Sensing Actuation Circuit Effects

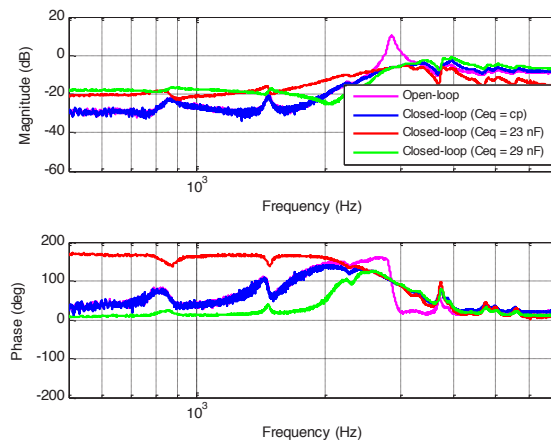

Figure 8. The frequency responses of the closed-loop system.

CONCLUSION

This paper presents a study of the self-sensing actuation circuit with the piezoelectric system when the circuit is balanced and unbalanced. The unbalanced SSA circuit affects the sensing voltage output of the SSA circuit when the amplitude of the control voltage is larger than the amplitude of the voltage generated from the piezoelectric actuator. In this case study, the unbalanced SSA circuit does not affect the closed-loop control system at the resonant frequency. The vibration of the piezoelectric system at the resonant frequency is attenuated by 16 dB in both the balanced and the unbalanced SSA circuit conditions. The self-sensing actuation circuit can be used with the single piezoelectric actuator to act as both the actuator and the sensor simultaneously for the vibration control in the piezoelectric system. In the future work, the unbalanced SSA circuit effects will be studied by applying the piezoelectric micro-actuator.

ACKNOWLEDGEMENT

Funds for this research came from Thailand Research Fund (TRF) and Western Digital (Thailand) Company Limited under the Research and Researchers for Industries (RRI) project No. PHD57I0051.

REFERENCES

- Dosch, J. J., Inman, D. J., & Garcla, E. (1992). A Self-Sensing Piezoelectric Actuator for Collocated Control. *Journal of Intelligent Material Systems and Structures*, 3(1), 166-185.
- Faegh, S., Jalili, N., & Sridhar, S. (2013). A Self-Sensing Piezoelectric MicroCantilever Biosensor for Detection of Ultrasmall Adsorbed Masses: Theory and Experiments. *Sensors*, 13(5), 6089-6108.
- Hong, F., & Pang, C.K. (2012). Robust vibration control at critical resonant modes using indirect-driven self-sensing actuation in mechatronic systems. *ISA Transactions*, 51, 834-840.

- Hong, F., Memon, A.M., Wong, W.E., & Pang, C.K. (2010). Indirect-Driven Self-Sensing Actuation for Dual-Stage HDDs with Improved Robustness. *ASME Information Storage and Processing Systems Conference* (pp. 141–143). Santa Clara, CA, USA.
- Ji, H. L., Qiu, J. H., Wu, Y. P., Cheng, J., & Ichchou, M. N. (2011). Novel Approach of Self-Sensing Actuation for Active Vibration Control. *Journal of Intelligent Material Systems and Structures*, 22(5), 449-459.
- Rakotondrabe, M., Ivan, I.A., Khadraoui, S., Lutz, P., & Chaillet, N. (2015). Simultaneous Displacement/Force Self-Sensing in Piezoelectric Actuators and Applications to Robust Control. *IEEE/ASME Transactions on Mechatronics*, 20(2), 519–531.
- Sasaki, M., Inoue, Y., & Yamada, H. (2012). Active Vibration Control of a Microactuator for the Hard Disk Drive Using Self-Sensing Actuation. *Smart Materials Research*.
- Seki, K., & Iwasaki, M. (2014). Improvement of Bending Vibration Suppression Performance for Galvano Mirror by Self-Sensing Actuation. *IEEJ Journal of Industry Applications*, 3(1), 10–17.
- Yamada, H., Sasaki, M., & Nam, Y. (2008). Active Vibration Control of a Micro-Actuator for Hard Disk Drives using Self-Sensing Actuator. *Journal of Intelligent Material Systems and Structures*, 19, 113-123.